

# TC Series

## Photo Triac

### Features

- Compact DIP8 Pin Package
- High Isolation Voltage 5000VAC between input and output
- 600VDC peak blocking Voltage
- Be suitable for 110/220VAC power voltage
- Random-on & Zero-on types are available

### Applications

- Power TRIAC driver
- Household appliance
- Solid State Relay



### Order Code:

TC 2 09 R - 7  
a b c d e

a : Model : TC=DIP 8 Pin Package Type  
b : Output Voltage : 2 = 240VAC  
c : Output Current : 09 = 0.9Amp ; 12 = 1.2Amp  
d : Turn on Type : Nil = Zero-on ; R = Random - on  
e : Option : Nil = DIP Type ; 7 = SMD Type

### Absolute Maximum Rating:

Item	Symbol	Rating		Unit	
		TC209(R)	TC212(R)		
Input	Forward Current	$I_F$	50	mA	
	Peak Forward Current	$I_{FP}$	1	A	
	Reverse Voltage	$V_R$	6	V	
Output	Off-state Output Voltage	$V_{DRM}$	600	VDC	
	On-state Output Current	$I_{R(RMS)}$	0.9	1.2	A
	Non-repetitive Surge Current	$I_{TSM}$	9	12	A
I/O Isolation Voltage		$V_{iso}$	5000	VAC	
Operating Temperature		$T_{opr}$	-30~+85	°C	
Storage Temperature		$T_{stg}$	-40~+125	°C	

### Electrical Characteristics:

Item	Symbol	MIN.	Rating		MAX.	Unit	Conditions
			TC209(R)	TC212(R)			
Input	Forward Voltage	$V_F$	-	1.18	1.4	V	$I_F=10mA$
	Reverse Current	$I_R$	-	-	10	$\mu A$	$V_R=6V$
Output	Peak Leakage Current	$I_{DRM}$	-	-	100	$\mu A$	$V_{DRM}=600V$
	On-state Voltage	$V_{TM}$	-	1.3	1.1	2.3	$I_R=Rated I_R$
	Hold Current	$I_H$	-	-	25	mA	$V_D=6V$
	Rise rate of off-state	$dv/dt$	200	1000	-	$V/\mu S$	$V_{DRM}=600V/\sqrt{2}$
Minimum trigger current		$I_{FT}$	-	2	10	mA	$V_D=6V$
Recovery Input Voltage		$V_{F OFF}$	0.5	-	-	V	
I/O Isolation Resistance		$R_{iso}$	50G	-	-		DC=500V
Turn-on Time (Random-on)		$T_{ON}$	-	8	100	$\mu S$	$I_F=20mA$
Turn-on Time (Zero-on)		$T_{ON}$	-	-	10	mS	-
Turn-off Time		$T_{OFF}$	-	-	10	mS	-

為了持續的改進，敝司有權在不影響規格範圍的情況下修改設計。

Note: Recommended trigger current is between 10mA and 20mA

In the interest of continuous development, our companies reserve the right to alter designs within specification range.

Dimensions : (Unit : mm)

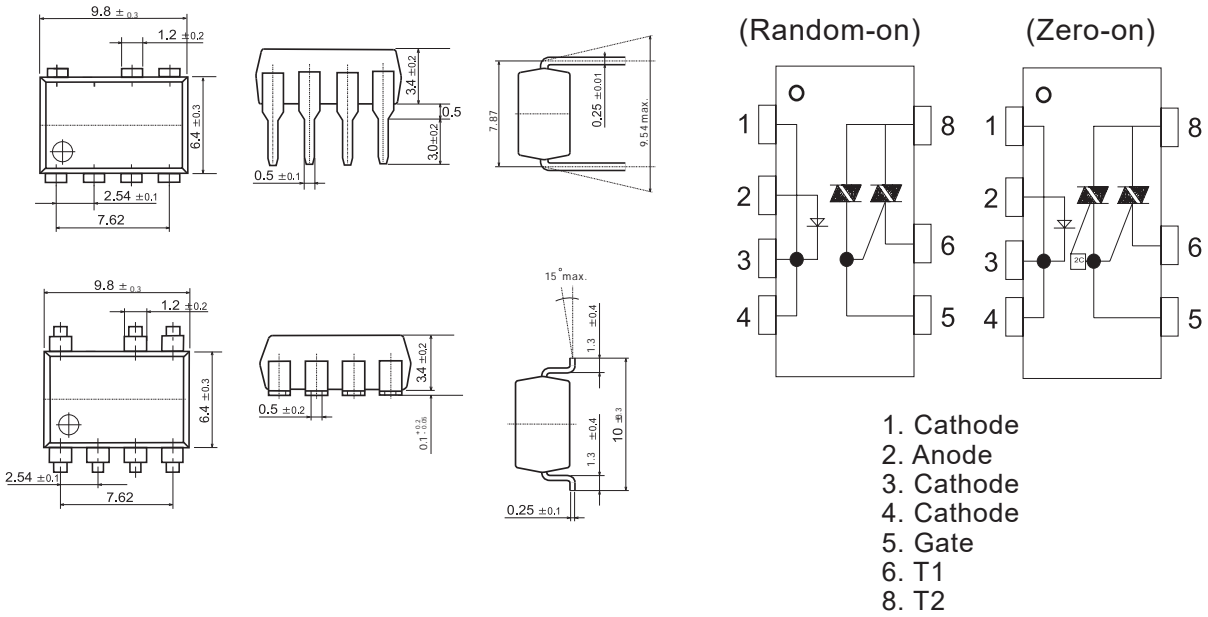

Wiring Diagram

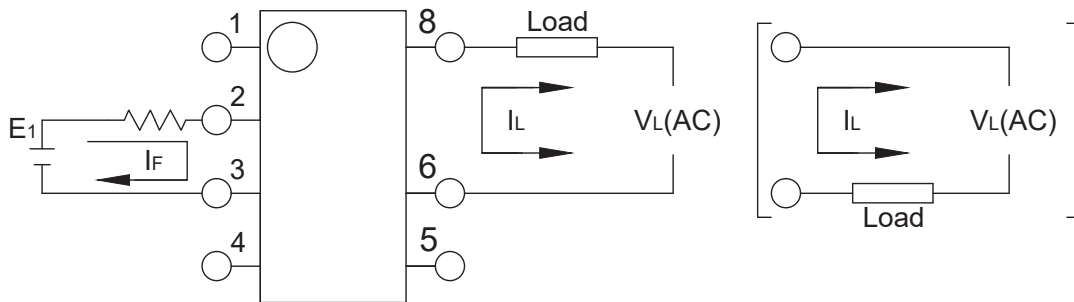

REFERENCE DATA :

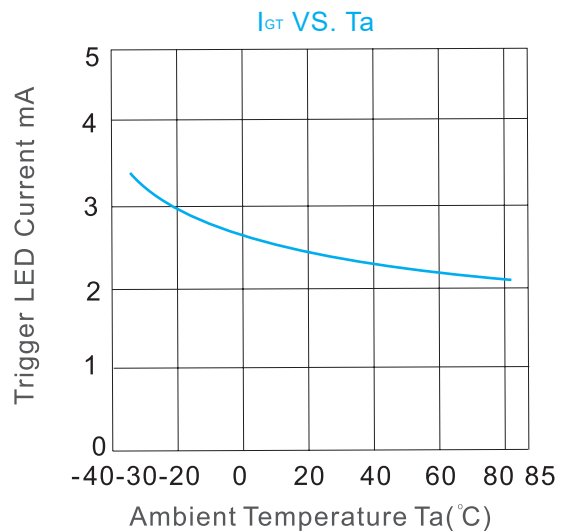
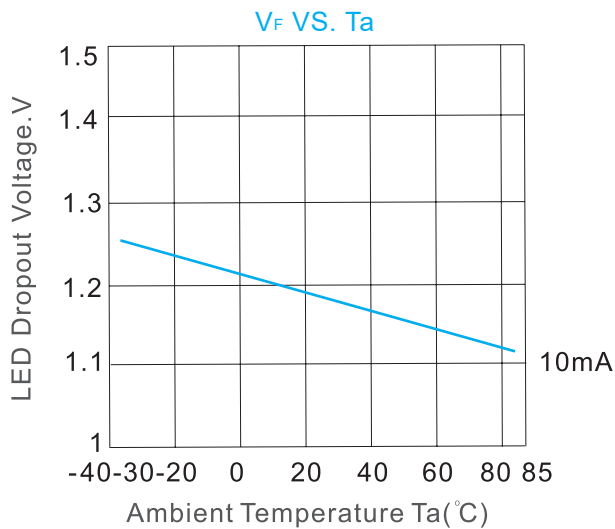

為了持續的改進，敝司有權在不影響規格範圍的情況下修改設計。  
In the interest of continuous development, our companies reserve the right to alter designs within specification range.

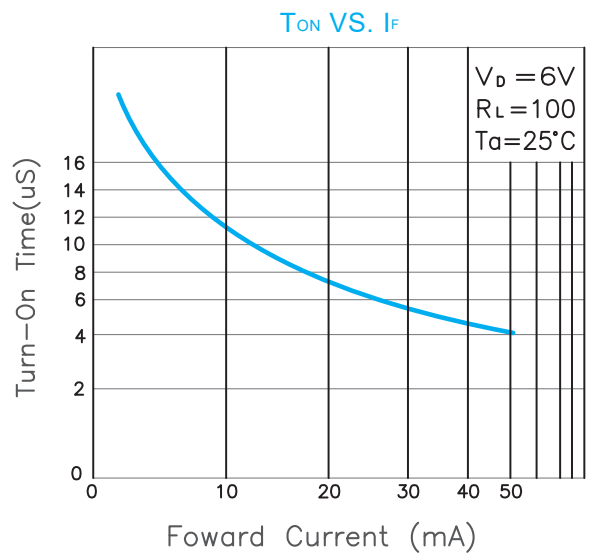
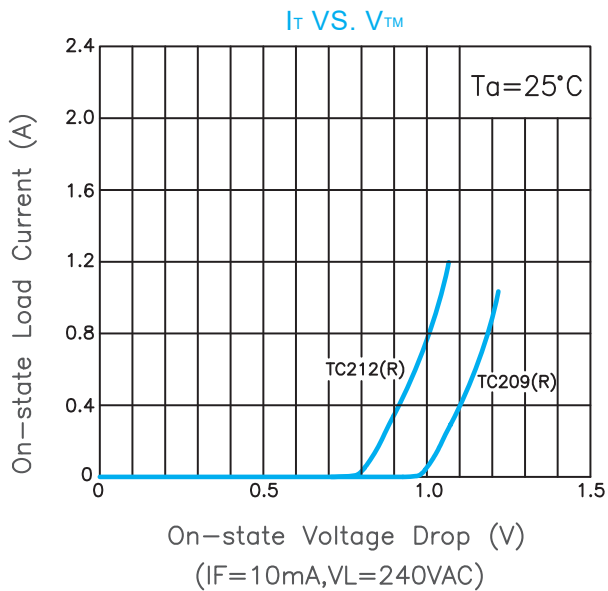
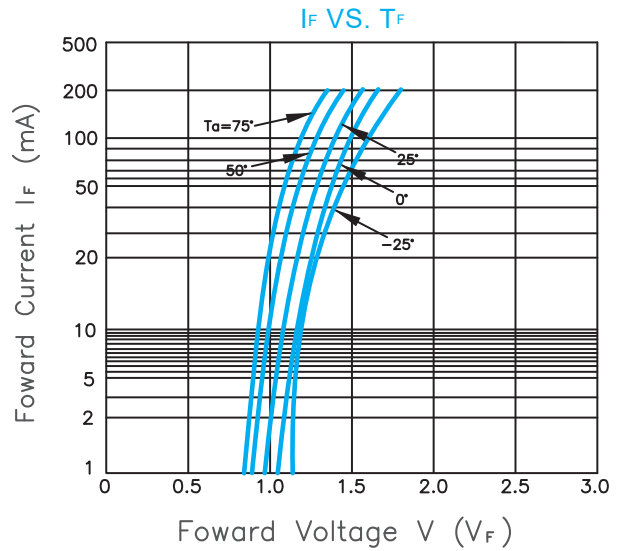
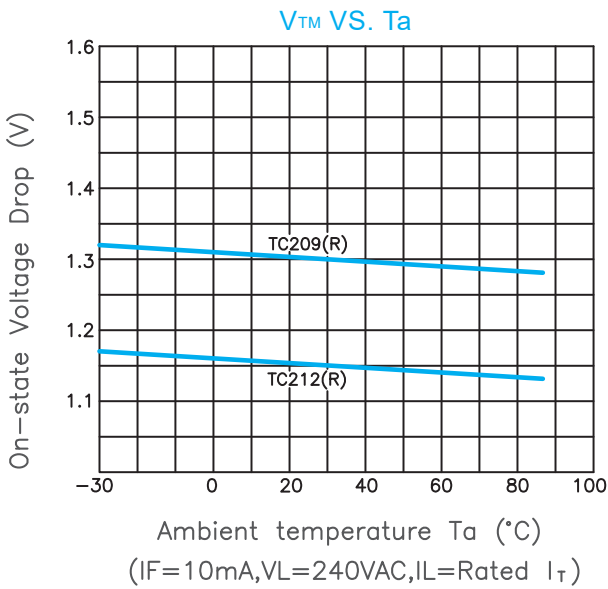
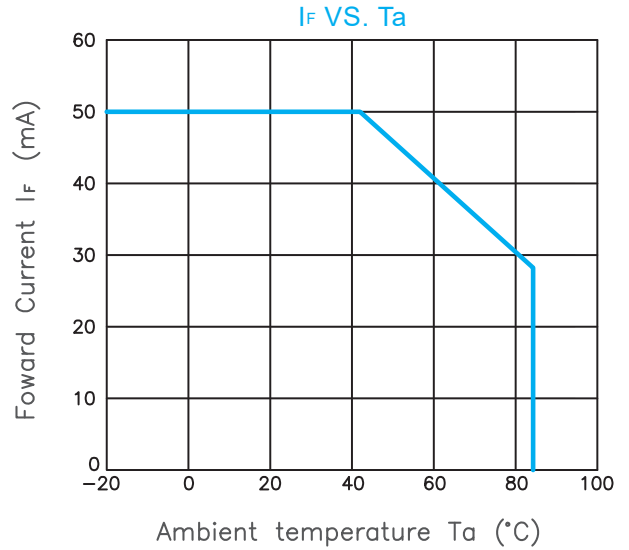
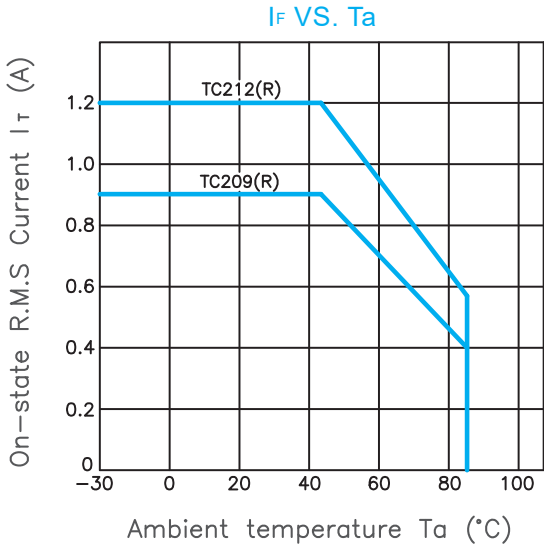

為了持續的改進，敝司有權在不影響規格範圍的情況下修改設計。

In the interest of continuous development, our companies reserve the right to alter designs within specification range.